

Chapter 10

WAVE MOTION

A.) Characteristics of Waves:

1.) A wave is *a disturbance that moves through a medium*.

a.) Example: A pebble is dropped into a quiet pond. The **DISTURBANCE** made by the pebble is what moves outward over the water's once-still surface. Water molecules are certainly jostled by the wave, but after the wave passes by, each molecule finds itself back in its original, pre-disturbance position (at least to a good approximation).

In other words, water waves are *not* made up of lumps of water that move across the water's surface. They are *disturbances* that move through the water that only temporarily displace water molecules in the process.

Note 1: A group of waves is called a *wave train*.

Note 2: Looking down from above, pebble-produced water waves will look like a series of crests and troughs moving in ever-expanding circles outward away from the pebble's point-of-entry into the water. If, at a given instant, lines are drawn on the crests, we find a visual presentation of the waves as shown in Figure 10.1b. Figure 10.1a shows a side-view of this same situation.

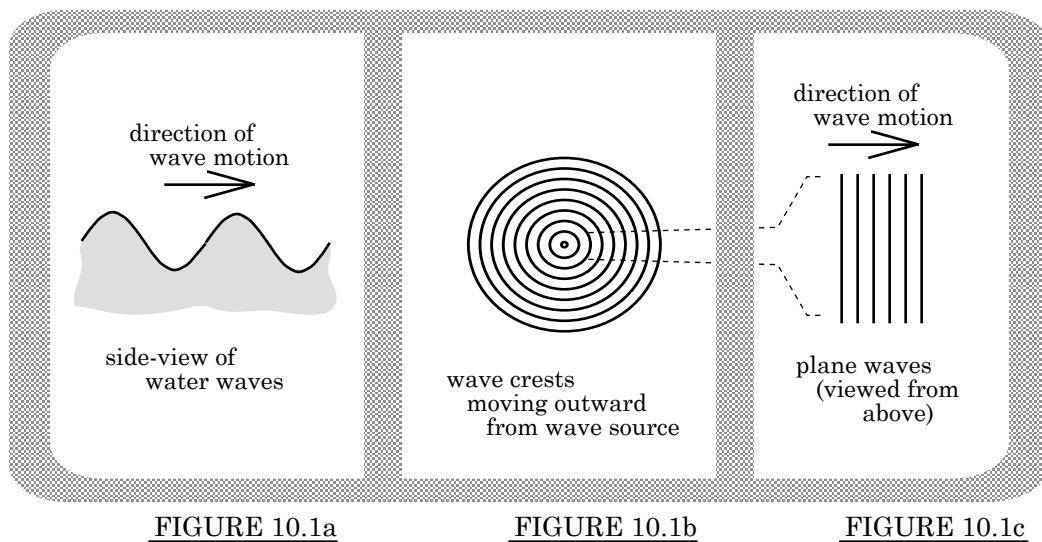

Note 3: Once a *wave train* has moved far enough away from its source, crests in the immediate vicinity of one another are to a very good approximation parallel to one another (look at the outer sections in Figure 10.1a). Waves in this situation are called *plane waves* and are shown on the previous page in Figure 10.1c. It is not uncommon for *plane waves* to be assumed when wave-phenomena are being discussed.

b.) A *sound wave* is a pressure disturbance that moves through air or water, or whatever the host medium happens to be.

Human vocal sound is generated by the back and forth vibration of the *vocal cords*. When these cords are extended, they momentarily compress air molecules together creating a high pressure region that is accelerated outward. As the cords pull back, they generate a momentary vacuum--a low pressure region (in between these two situations, the air pressure obviously passes through a "normal" pressure circumstance). In other words, the vibration of the vocal

cords creates regions of high pressure, then normal pressure, then low pressure, then normal pressure, then high pressure, etc., as they vibrate back and forth (Figure 10.2a presents a representation of what sound waves

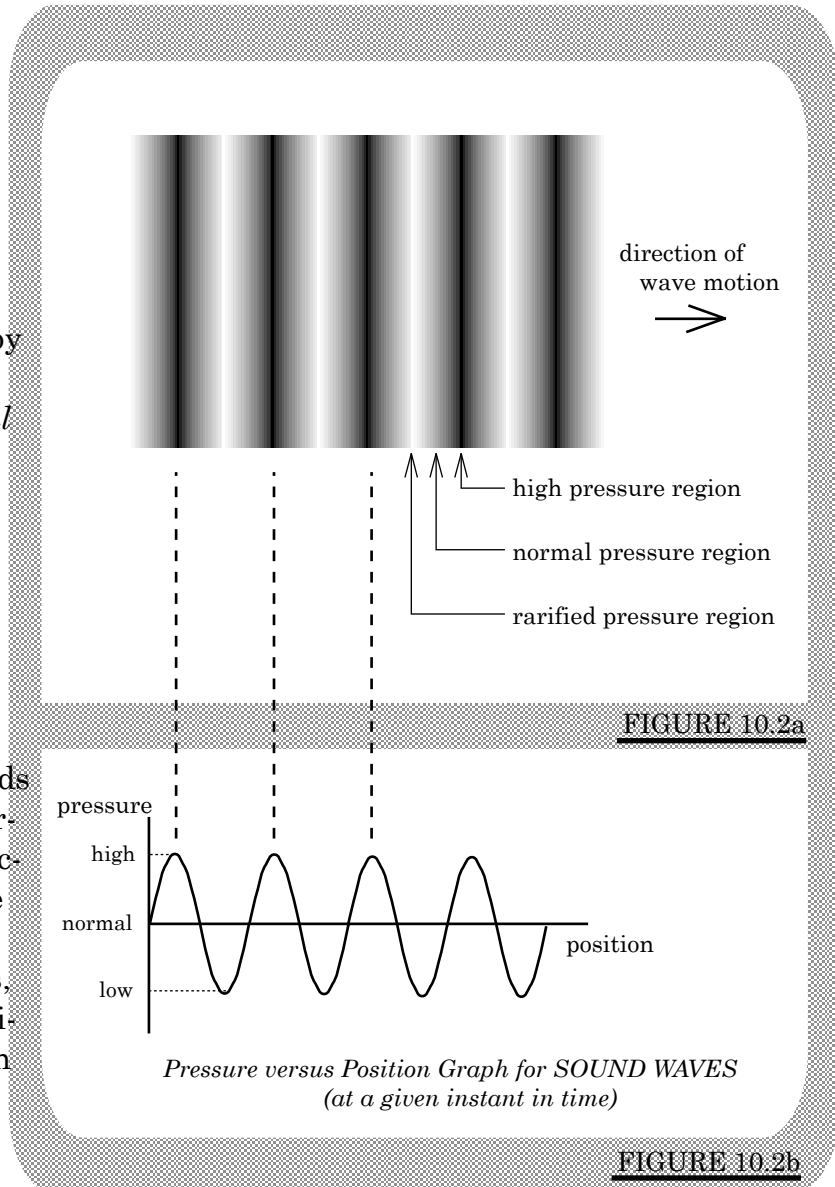

would look like if our eyes were sensitive to very subtle pressure variations--Figure 10.2b graphs *pressure variation* versus *position* for sound at a *given point in time*).

These *pressure disturbances* move out into the surrounding air at approximately 330 meters per second (i.e., the *speed of sound*). As they pass a hearing person, the pressure variations motivate tiny hairs in the listener's ears to vibrate generating electrical signals which, upon reaching the brain, are translated into incoming sound.

Again, sound waves are a *disturbance moving through a medium*. Without the medium, there can be no sound.

Note: That's right, the next time you see *Star Wars* and they show a big battle scene viewed from space, you have every right to stand up in the middle of the movie theater and shout at the top of your lungs, "WAIT, WAIT, THIS CAN'T BE. THERE IS NO SOUND IN SPACE!!" They'll probably throw you out of the theater for causing a disturbance (i.e., for making waves--a little physics humor), but you will be correct in exposing one of Hollywood's greatest displays of scientific misinformation ever.

2.) Waves are important because they carry *energy*.

Note: If you think about it, this should be obvious. If waves didn't carry energy, *sound waves* wouldn't have the wherewithal to wiggle those little ear-hairs that allow you to hear, and *tidal waves* would not have the ability to blow away whole island-populations with a single achoo.

3.) There are two kinds of waves, both of which are identified by how *the disturbance-producing force* is applied:

a.) Transverse waves: These are waves that are created by a force that is applied to a medium *perpendicular* to the direction of the wave's motion in the medium.

i.) An example: When a *pebble* enters a pond, it applies a *force* to the water that is *perpendicular* to the water's surface, hence *perpendicular* to the wave's direction, as it moves out over the water's surface. As such, this is a *transverse wave*.

b.) Longitudinal waves: These are waves created by a force applied to a medium *in the same direction* as the wave's motion in the medium.

i.) An example: When sound from a loud-speaker is produced, the speaker cone applies a force to air molecules that is *in the same direction* as the subsequent pressure-waves that move out from the device.

4.) Wave reflection:

a.) Consider a taut rope fixed to a door. Flicking the rope at the unattached end will produce a single wave that will travel down the rope (see Figure 10.3a). When it gets to the door, the wave will bounce off the fixed end, flip 180° (π radians; one-half a cycle; whatever--see Figure 10.3b) and proceed back down the line. This half-wave inversion is typical of wave-reflection off *fixed ends*.

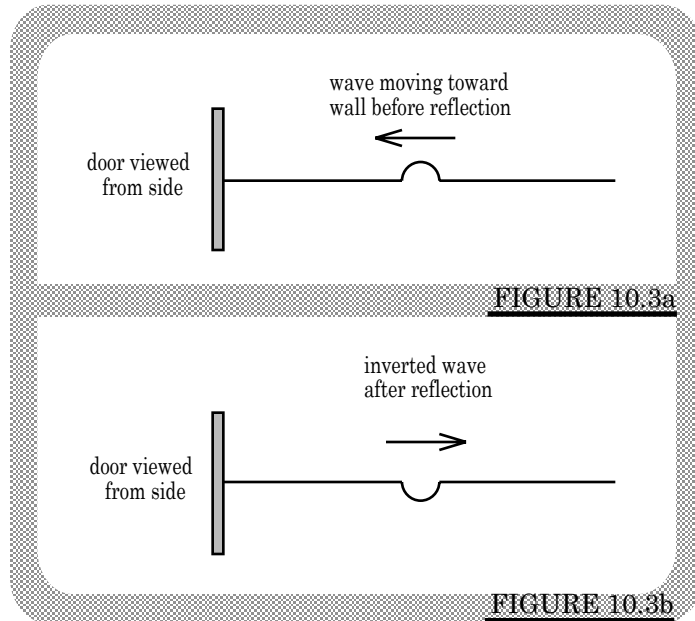

b.) Consider a rope hanging freely from a ceiling. A single wave moving downward (see Figure 10.4a) will bounce off the free bottom and proceed back up toward its origin.

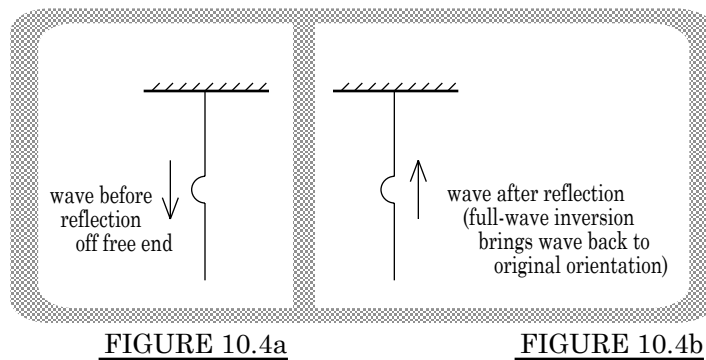

The bounce-back flips the wave 360° (i.e., it comes back to its original position) before the wave proceeds back up the rope (see Figure 10.4a). This full-wave inversion (net effect--no inversion at all) is typical of wave reflection off *free ends*.

5.) Some DEFINITIONS:

a.) Wave-length (λ in meters): the distance between two successive crests, or two successive troughs, or between two successive positions along the wave that are exact duplicates of one another (see Figure 10.5).

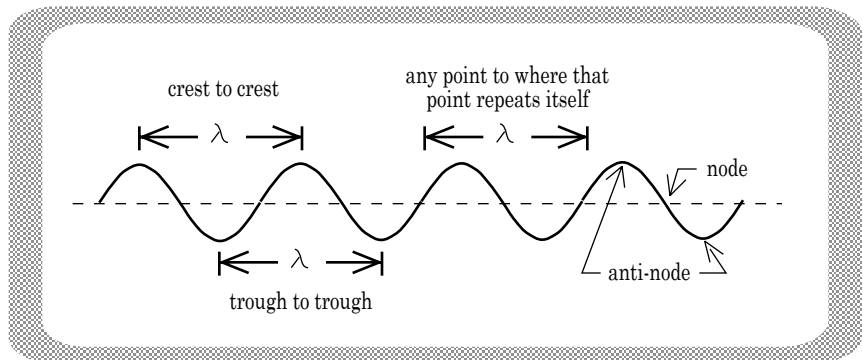

FIGURE 10.5

b.) Frequency ("ν" in cycles/second--this symbol is a Greek "nu"): the *number of wavelengths* that pass a fixed observer *per second*.

c.) Period ("T" in seconds/cycle): the *time* required for one full wavelength to pass a fixed observer. As in vibratory motion, $T = 1/\nu$.

d.) Wave velocity ("v" in meters/second): the velocity of a wave disturbance as it moves through its medium. Mathematically:

$$v = \lambda \nu.$$

(Don't believe me? Check the units.)

A consequence of this relationship: for a given wave, *high frequency* corresponds to *short wavelength* and vice versa.

e.) Nodes and anti-nodes: a *node* is a null spot on the wave. It corresponds to a place where the displacement of the wave is zero (see Figure 10.5). An *anti-node* is a spot where the displacement is a maximum. It corresponds to a crest or trough (see Figure 10.5).

f.) Superposition of waves: when two waves in the same medium run into one another, the two disturbances will add to one another in a linear way. Given such a situation, there are a number of outcomes:

i.) Constructive superposition: a situation in which the two waves momentarily produce a single wave that is *larger* than the original two. For two waves with the same amplitude A , completely *constructive superposition* will yield a displacement of $2A$.

ii.) Destructive superposition: a situation in which the two waves produce a single wave that is *smaller* than the largest of the original two. For two waves with the same amplitude A , completely *destructive superposition* will produce a net displacement of zero.

iii.) Figure 10.6a shows two waves (one denoted with dots, one denoted with dots and dashes) moving in opposite directions in the same medium. Figures 10.6b and 10.6c show the waves at various stages of superposition.

B.) Mathematics of Traveling Waves:

1.) The displacement of a traveling sine wave is a function of both *time* and *position*. Its displacement will vary *at a given time* from place to place in addition to varying *at a given place* as time proceeds.

2.) The function that characterizes this situation is:

$$y(x,t) = A \sin(kx \pm \omega t),$$

where A is the amplitude of the wave, k (the *wave number*) is defined as $2\pi/\lambda$ (just as ω --the angular frequency--governs how fast the function changes relative to time, k governs how fast the function changes relative to position--it is like a *positional-frequency* function), and x and t are the two variable-parameters that allow one to zero in on a *particular place* at a *particular time of interest*.

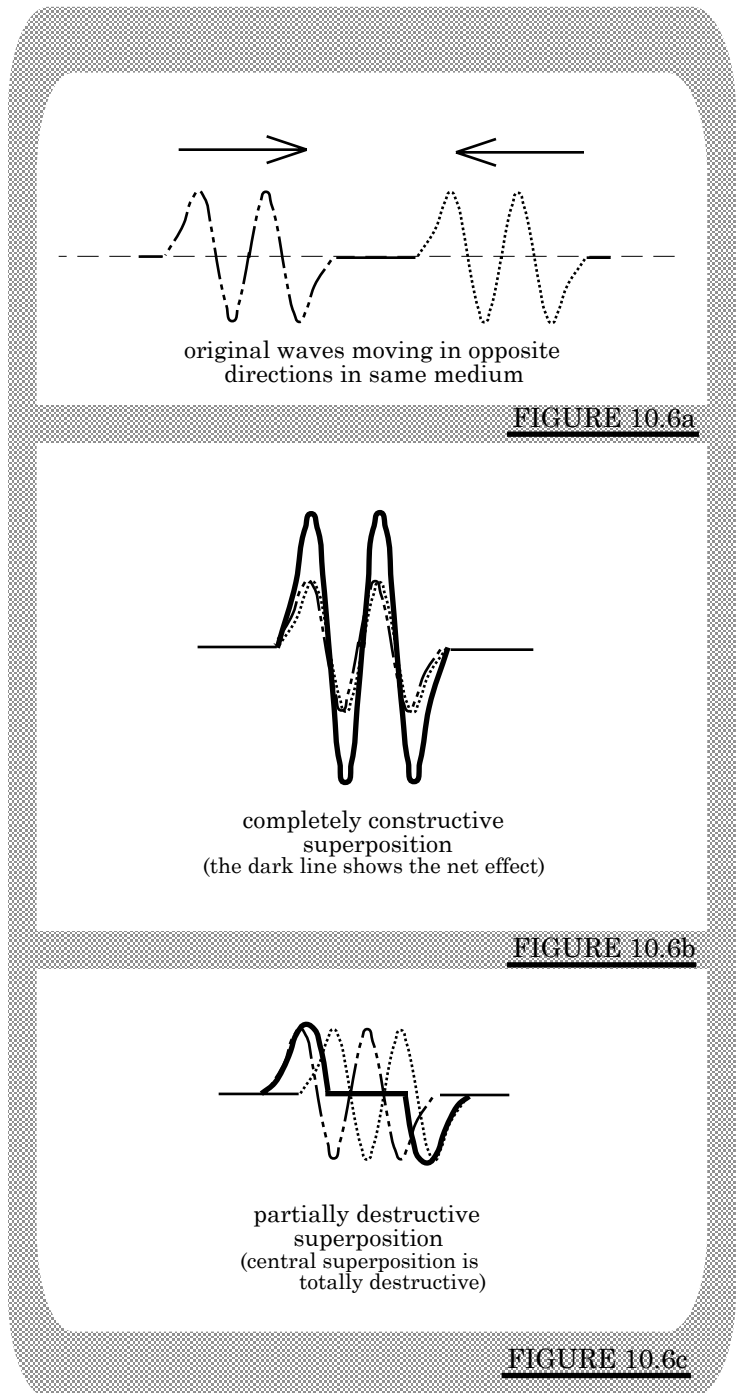

C.) Resonance:

1.) Vibrating systems usually have at least one *frequency* at which the system will naturally vibrate. A swing, for instance, acts like a pendulum. In the last chapter, we found that for small angles the *frequency* of a pendulum is dependent upon the *acceleration of gravity* and the *length of the pendulum arm*. Assuming neither of those changes in a given situation, a pendulum has only *one frequency* at which it will freely, naturally oscillate (in fact, this is approximately true even for moderately large amplitude oscillations). Although you haven't run into any yet, there are systems that have more than one *natural frequency*.

2.) *Resonance* is a situation in which the *frequency* of an *applied force* matches one of the *natural frequencies* of the system to which the force is applied. The consequence of such a condition is an increase in the system's *energy* and *amplitude of vibration*.

3.) Example: Consider a mass attached to the spring shown in Figure 10.7. Every such spring/mass combination will have one natural frequency at which the system will oscillate (remember $\nu = [(k/m)^{1/2}]/2\pi$?). For this example, assume that the *natural frequency* is *1/2 cycle per second*. As the period is $T = 1/\nu$, the *period* of this oscillation will be *2 seconds per cycle*. With the mass at rest:

a.) A force is briefly applied to the mass, then applied periodically for just a moment every 1.75 seconds (see Figure 10.7). Will the force help or hinder the oscillatory motion?

i.) As the *force's frequency* is out of sync with the *natural frequency* of the system, it doesn't take a genius to see that the force will fight the natural motion of the system. The consequence: the mass's motion will be disorderly and chaotic.

b.) Another possibility: the *frequency* of the *applied force* is now *2 seconds/cycle*. Under this condition, the push comes each time the mass is at its lowest point--each time the mass is naturally ready to start upwards again. The force helps the motion because the *frequency of the applied force* matches the *natural frequency* of the oscillating system. As

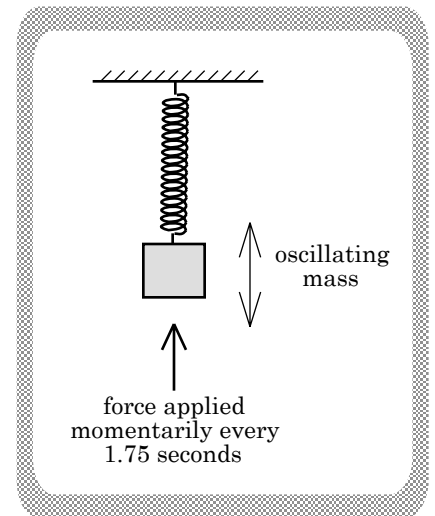

FIGURE 10.7

such, the *amplitude* of the motion gets bigger and bigger with each cycle, and the *energy* of the vibrating system increases.

Note: You might at first think that because the *amplitude* of the oscillation is changing, the frequency must change. Not so for ideal springs. The *frequency* of an oscillating spring/mass system is *not* a function of *amplitude*; the *frequency* will remain the same no matter how large the *amplitude*.

D.) Resonance and String Systems:

1.) A more complex *resonance* situation is found in what are called *standing waves*.

Note: Although a *spring* has only one natural frequency, a *string* system has an infinite number of possible natural frequencies. Why this is so will become evident shortly.

a.) Consider a rope of length L and mass density h (h is the rope's mass/length) stretched taut between two fixed points. A small *transverse force* is periodically applied at one end creating a series of waves moving down the string (this is called a *wave train*). As the waves move, each will sooner or later bounce off the fixed end, flipping a half-cycle before proceeding back toward its origin. These reflected waves will run into newly formed waves coming in the other direction and a *superposition of waves* will take place along the entire string.

b.) Just as was the case with the mass/spring system, the *frequency of the applied force* has a lot to do with how this superposition proceeds.

i.) If there is no *applied force* once the first few waves are set in motion, the waves will travel up and back and up and back until frictional effects dampen them out (this usually happens quickly).

ii.) What happens if the *applied force* at *Point A* continues after the first few waves are formed? In that case, it depends upon the frequency of the *applied force*. If the *frequency* is out of sync with the *natural frequency* of oscillation on the string, the returning waves will be met by an *applied force* that fights their natural motion. The net result will be a *superposition* of incoming and outgoing waves along the string that is disorganized and the string will jerk around chaotically.

Note: This is just like applying a force whose frequency is *1.75 cycles per second* to a swing whose natural frequency is *2 cycles per second*.

iii.) If, on the other hand, the *frequency of the applied force* matches one of the *natural frequencies* of the system, the *applied force* will reinforce the waves bouncing off *Point A* and the superposition that subsequently occurs on the string will be orderly and well defined. When such a situation arises, the *net wave* formed on the string is the consequence of superposition and is called a *standing wave*.

iv.) At a given instant, the waveform for the standing wave described above will look like a *sine wave*. Because the wave's net displacement is constantly changing quickly, such standing waves usually look like the blurred form shown in Figure 10.8a. Figure 10.8b uses a strobe effect to show a snapshot view of the string at different points in time.

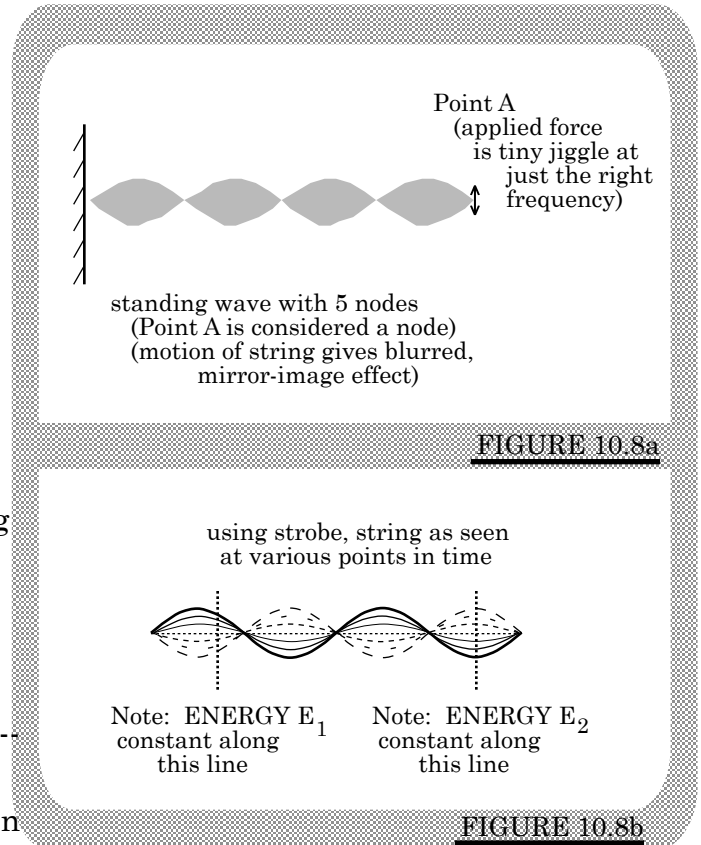

Note: A given point on the string will move up and down with simple harmonic motion. In terms of *energy*, that means *each point* will have energy $(1/2)kA_p^2$ associated with it, where k is some constant and A_p is the amplitude--the maximum displacement--of that point. As the amplitude of each point on the string varies, the amount of energy associated with each point on the string will be different.

This fact is where the name *standing wave* came from. True, the point displacements vary so fast that the net wave looks like a single, blurred, two-dimensional standing form, but in fact the name was originated to honor the fact that the *energy of a particular point stands constant throughout the motion* (see Figure 10.8b).

v.) Bottom line: When an *applied force* is in sync with one of the *natural frequencies* of a string system, resonance occurs and the displacement of each point on the string is found to move in a very precise, harmonious way. The net effect is to produce string motion that outlines a mirror-image sine wave.

2.) In terms of the system's parameters (i.e., wave velocity v , string length L , etc.), how can we determine the *natural frequencies* of a string system (i.e., what is the lowest natural frequency, the *second lowest natural frequency*, etc.) and, hence, the *applied-force frequencies* that will allow the system to *resonate*?

The answer to that question is outlined below.

a.) Observation #1: Begin by considering the standing wave shown in Figure 10.9.

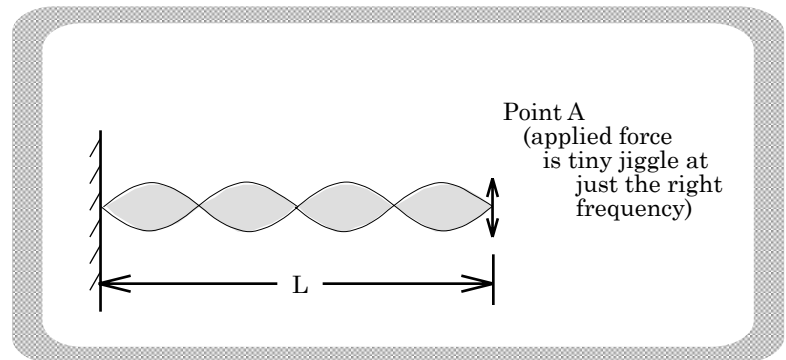

FIGURE 10.9

b.) Observation #2: We know that there exists a relationship between a wave's velocity v , wavelength λ_a , and wave frequency ν_a . It is: $v = \lambda_a \nu_a$.

Note: If we can determine both the wave velocity v and the wave's wavelength λ_a when our standing wave exists on the string, we can use the above relationship to determine the natural frequency ν_a that corresponds to that standing wave.

c.) Observation #3: There is a known relationship between the velocity v of a wave moving on a string of tension T and mass density h . That relationship is: $v = (T/h)^{1/2}$.

d.) Observation #4: By inspection, we can determine a standing wave's wavelength λ_a in terms of the known string length L . Looking at Figure 10.9 we ask, "How many wavelengths of length λ_a are there in the length L ?" Mathematically, this is like querying, "Find the N in the equation $N\lambda_a = L$." Examining Figure 10.9, it is obvious that there are two λ_a 's in the length L , or $2\lambda_a = L$. From this, we get $\lambda_a = L/2$.

e.) Observation #5: With the information found in Observations 2, 3, and 4, we can determine the *natural frequency* of the wave shown in Figure 10.9. It is:

$$v = \lambda_a v_a.$$

$$\Rightarrow v_a = v/\lambda_a$$

$$= v/(L/2).$$

f.) We have just found one *natural frequency* at which a system will oscillate; we now know one *applied-force frequency* at which that system will *resonate*.

3.) This approach works fine as long as you have the sketch. What happens when that isn't the case? What happens when the question simply states, "Given a string length L and wave velocity v , determine the *three lowest frequencies* of wave that can stand on this system?"

Using an "observation" approach:

a.) Observation #1: Figures 10.10 a, b, and c show *different frequency* standing waves standing on the same system (i.e., the same length of string). What do they have in common?

i.) In all cases, there are *nodes at each end of the string*. Each wave has a wavelength that fits the constraint of having nodes a distance L meters apart.

ii.) Does this make sense? Certainly! The string is *fixed* at each end. That means there can be no motion at those points (as the force at *Point A* has a tiny amplitude--it is legitimate to ignore it, calling *Point A* a node).

b.) Observation #2: If you didn't *have* the sketches to look at, could you have created them? Yes!

i.) Draw a sine wave (see Figure 10.11 on the next page).

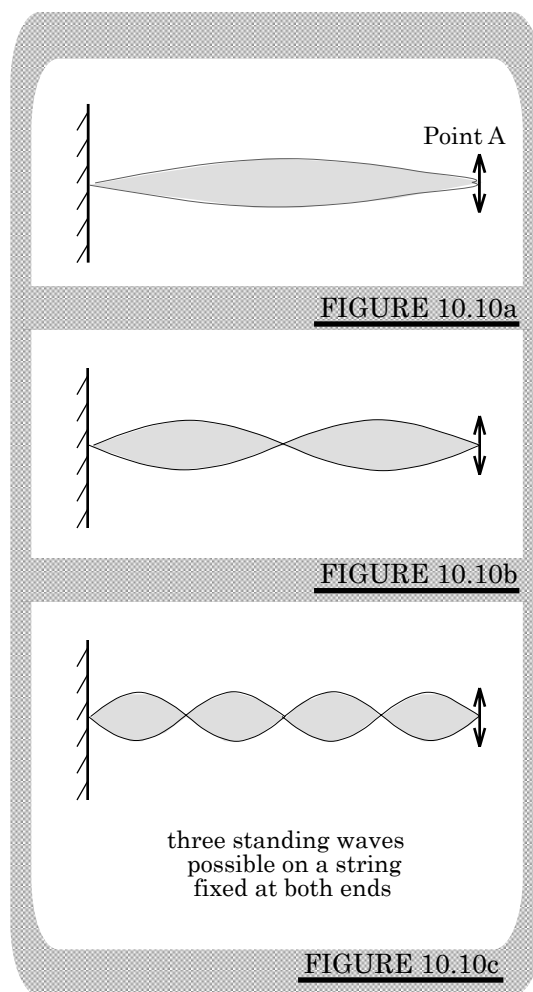

ii.) Determine the left-end constraint for your system (the left-end constraint in our example is a node). Proceed toward the right along the *sine wave* until you come to a point that matches the *right-end constraint* (in our example, this is another node). If

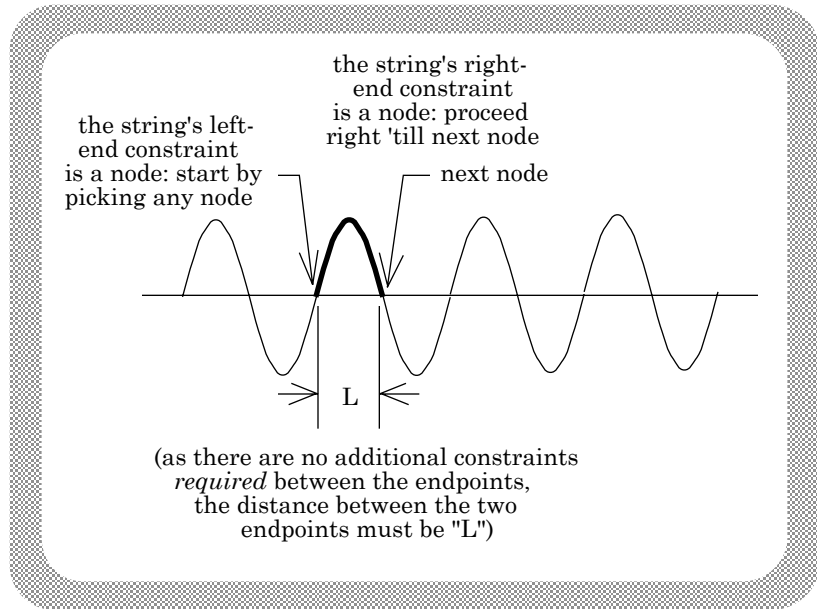

FIGURE 10.11

there are no other constraints between the endpoints (i.e., there are no forced nodes in between due to somebody *holding the string*), *the waveform between the endpoints will be the longest wavelength waveform* (i.e., *lowest frequency waveform*) THAT FITS THE CONSTRAINTS OF THE SYSTEM.

iii.) From here, you can either re-draw the section-of-sine-wave you are interested in, or simply use the original drawing to put in the length L (Figure 10.11 shows L placed directly onto the working *sine wave*).

iv.) Having the sketch, you can then proceed to ask, "How many wavelengths are there in the length L ?" Mathematically, this can be written:

$$N\lambda_n = L.$$

Once answered, proceed from there.

Note: If you want the *second lowest frequency* for the example, the process is exactly the same. Draw a sine wave; match the string's *left-end constraint* (a node in this case) with a point on the sketch; proceed to the right until you find a point that matches the string's *right-end constraint*. If the waveform encompassed between those two points has already been used (in this case, the *two-consecutive-nodes* waveform was used for the lowest frequency waveform), continue to the right until you find the *next* point that satisfies the right-end constraint (see Figure 10.12). If there are no additional constraints between the two ends

(nobody is holding the string in the middle somewhere), *the waveform you see in between your two chosen points* (both nodes in this case) will correspond to the *second longest wavelength* waveform (i.e., the *second lowest frequency* waveform). Define the distance between the two endpoints as L and proceed as before.

4.) Consider a string of length L constrained to hang from the ceiling as shown in Figure 10.13. Assume the velocity of a wave moving on the string is a known v . If a *small, periodic, transverse force* is applied to the string at the ceiling, what are the *two lowest frequencies* at which the string will *resonate*? That is, what are the two lowest frequencies that can *stand* on the string?

a.) First, we need to identify the constraints. They are:

- i.) A node at the ceiling (ignoring the applied jiggle the string is fixed there);
- ii.) An anti-node at the free end; and
- iii.) There are no additional constraints between the two ends.

b.) With the constraints in mind, consider the vertical sine wave shown in Figure 10.14 (a vertical *sine wave* has been used to better reflect the situation--a horizontal sine wave would have worked just as well). Beginning at any convenient node (there must be a node at the ceiling), proceed down until you run into the first anti-node (this is the constraint at the free end). The *longest wavelength* waveform that can fit the system's constraints is the smallest section of sine wave to fit the constraints (see Figure 10.14).

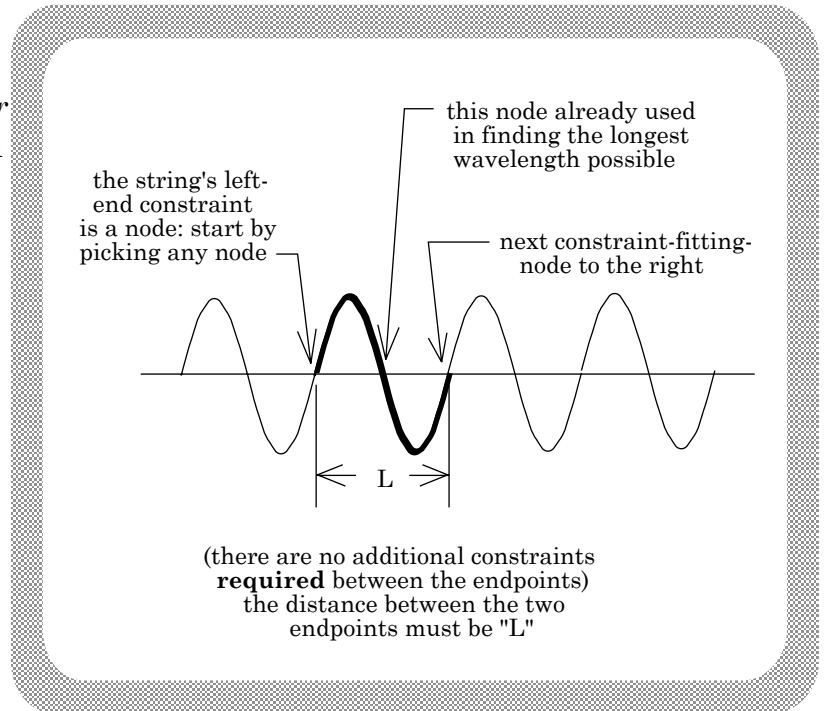

FIGURE 10.12

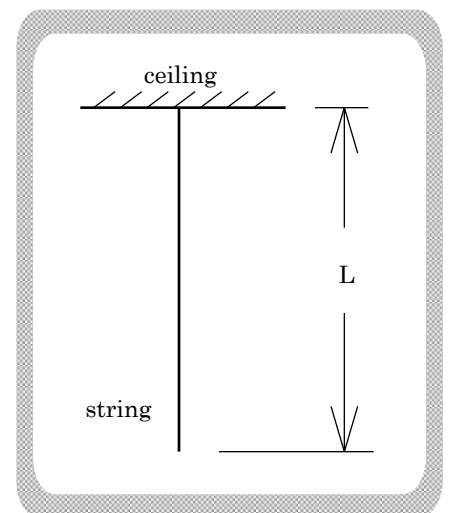

FIGURE 10.13

i.) You can re-draw this waveform or put L on the original waveform as is done in Figure 10.14.

c.) Asking the question: How many of these wavelengths are there in the length L , or $N\lambda_1 = L$, we get:

$$\begin{aligned} (1/4) \lambda_1 &= L \\ \Rightarrow \lambda_1 &= 4L. \end{aligned}$$

d.) Putting it all together, we end up with:

$$\begin{aligned} v &= \lambda_1 \nu_1 \\ \Rightarrow \nu_1 &= v/\lambda_1 \\ &= v/(4L). \end{aligned}$$

e.) Following a similar series of steps, the *second longest wavelength* waveform to satisfy the constraints is shown in Figure 10.15. The math yields:

$$\begin{aligned} (3/4) \lambda_2 &= L \\ \Rightarrow \lambda_2 &= (4/3)L. \end{aligned}$$

As $v = \lambda_2 \nu_2$, we can write:

$$\begin{aligned} \nu_2 &= v/\lambda_2 \\ &= (3v)/(4L). \end{aligned}$$

Note: Although you can have either a node or anti-node at a given end, you can only have nodes *in between* endpoints as there is no way to force a system to exhibit *anti-nodes* in its mid-section.

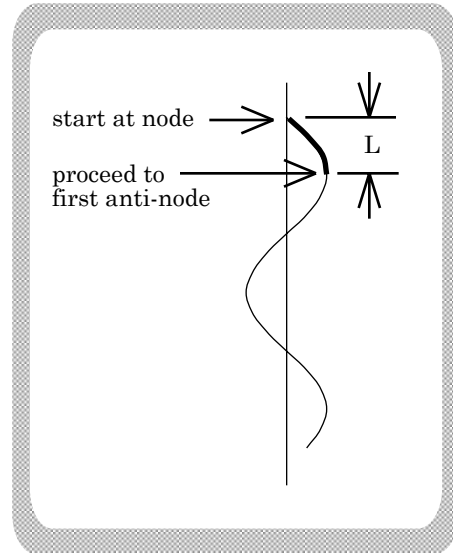

FIGURE 10.14

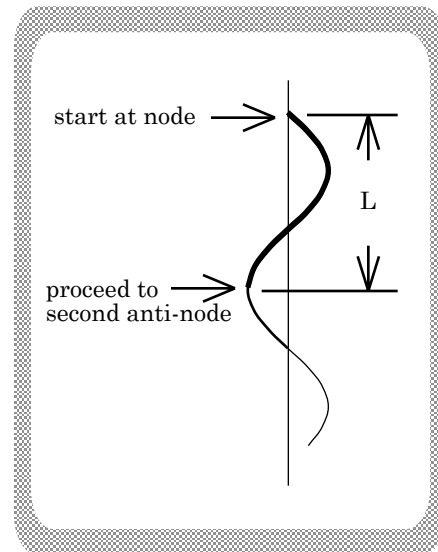

FIGURE 10.15

E.) Resonance and a Steel Bar:

1.) Consider the bar of length L shown in Figure 10.16. It is constrained by a clamp located half way down the bar's length. If the bar is tapped once at the end, a series of waves will be found to "stand" on the bar. If the velocity of the waveform on the bar is a known value v , what are the *two lowest frequencies* at which the bar will ring?

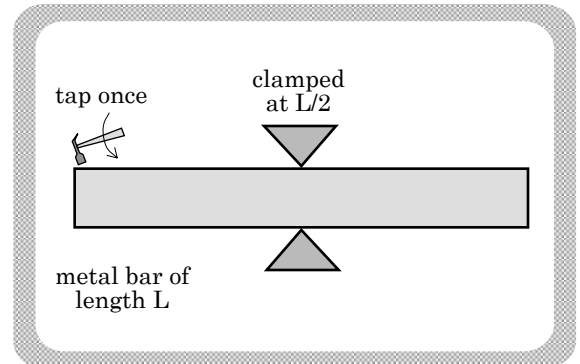

FIGURE 10.16

a.) The constraints: *anti-nodes at both ends* and *a node in the middle*.

b.) Consider the *sine wave* drawn in Figure 10.17.

i.) If we start at the *anti-node* at *Point A* and proceed to the right, the next *anti-node* we come to is located at *Point C* on the sketch. That takes care of the end constraint. But . . .

ii.) The waveform we are looking for must additionally have a *node* in the middle. Fortunately

for us, this waveform *has* a node halfway between the endpoints, which means we have found the longest wavelength (lowest frequency) wave form that conforms to the constraints of the problem.

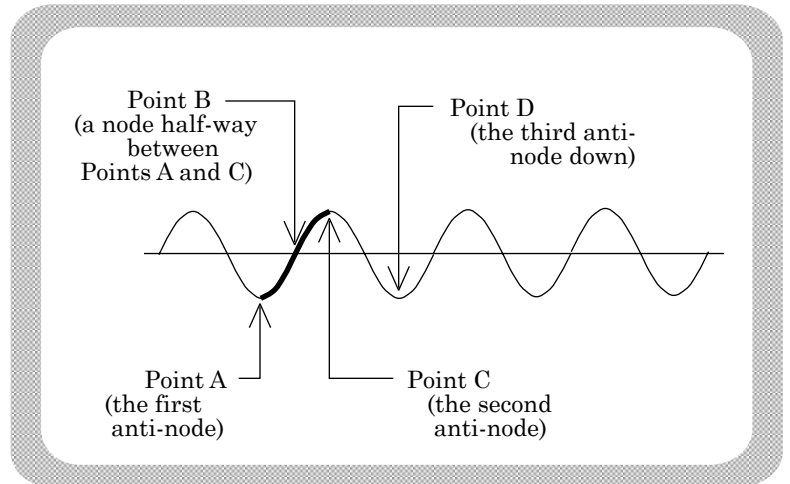

FIGURE 10.17

c.) The math proceeds just as it did with the *string systems*: We begin by asking, "How many λ 's in L ?" Proceeding yields:

$$\begin{aligned} (1/2)\lambda_1 &= L \\ \Rightarrow \lambda_1 &= 2L. \end{aligned}$$

As $v = \lambda_1 v_1$, we can write:

$$\begin{aligned} v_1 &= v / \lambda_1 \\ &= v / (2L). \end{aligned}$$

d.) For the *second longest wavelength* waveform, it might be tempting to assume the third anti-node (the one located at *Point D* in Figure 10.17 on the previous page) is the appropriate choice. A closer look shows that the waveform extending from *Point A* to *Point D* has an *anti-node* at its center. Our constraints require a node.

The waveform that matches our constraints extends from *Point A* to *Point E* in Figure 10.18. The math yields:

$$\begin{aligned} (3/2) \lambda_2 &= L \\ \Rightarrow \lambda_2 &= (2/3) L. \end{aligned}$$

As $v = \lambda_2 v_2$,

$$\begin{aligned} v_2 &= v / \lambda_2 \\ &= (3v) / (2L). \end{aligned}$$

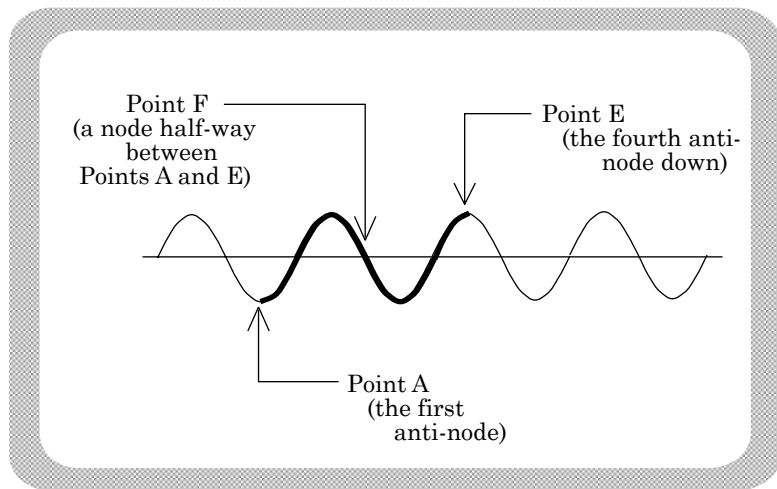

FIGURE 10.18

2.) Consider the bar shown in Figure 10.19. It is constrained by a clamp *at one end* and by a second clamp located *two-thirds of the way down the bar's length*. What are the *two lowest frequencies* at which this bar system will ring?

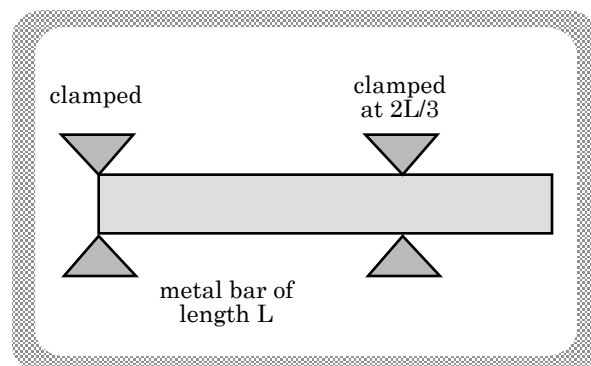

FIGURE 10.19

a.) The constraints: a node at one end, a node two-thirds of the way down the bar, and an *anti-node* at the other end.

b.) The longest waveform to conform to our constraints is shown in Figure 10.20a on the next page.

c.) With a sketch of the appropriate waveform, we write:

$$\begin{aligned} (3/4) \lambda_1 &= L \\ \Rightarrow \lambda_1 &= (4/3)L. \end{aligned}$$

$$\text{As } v = \lambda_1 v_1,$$

$$\begin{aligned} v_1 &= v / \lambda_1 \\ &= (3v)/(4L). \end{aligned}$$

d.) Following a similar series of steps, the *second longest wavelength* waveform to satisfy the constraints is shown in Figure 10.20b. The math yields:

$$\begin{aligned} (9/4) \lambda_2 &= L \\ \Rightarrow \lambda_2 &= (4/9)L. \end{aligned}$$

$$\text{As } v = \lambda_2 v_2,$$

$$\begin{aligned} v_2 &= v / \lambda_2 \\ &= (9v)/(4L). \end{aligned}$$

Note: The temptation might have been to go to the node just after the anti-node used in the "longest wavelength" part of the problem, or for that matter the anti-node after that one (see "won't do" note on Figure 10.20b). The problem with both of these choices is that there is no node *two-thirds of the way* between either of them and the node at *Point A*. All the constraints must be met before we have our waveform.

3.) Understand this approach to the point where you can find the two or three *lowest frequencies* for any combination of clamps.

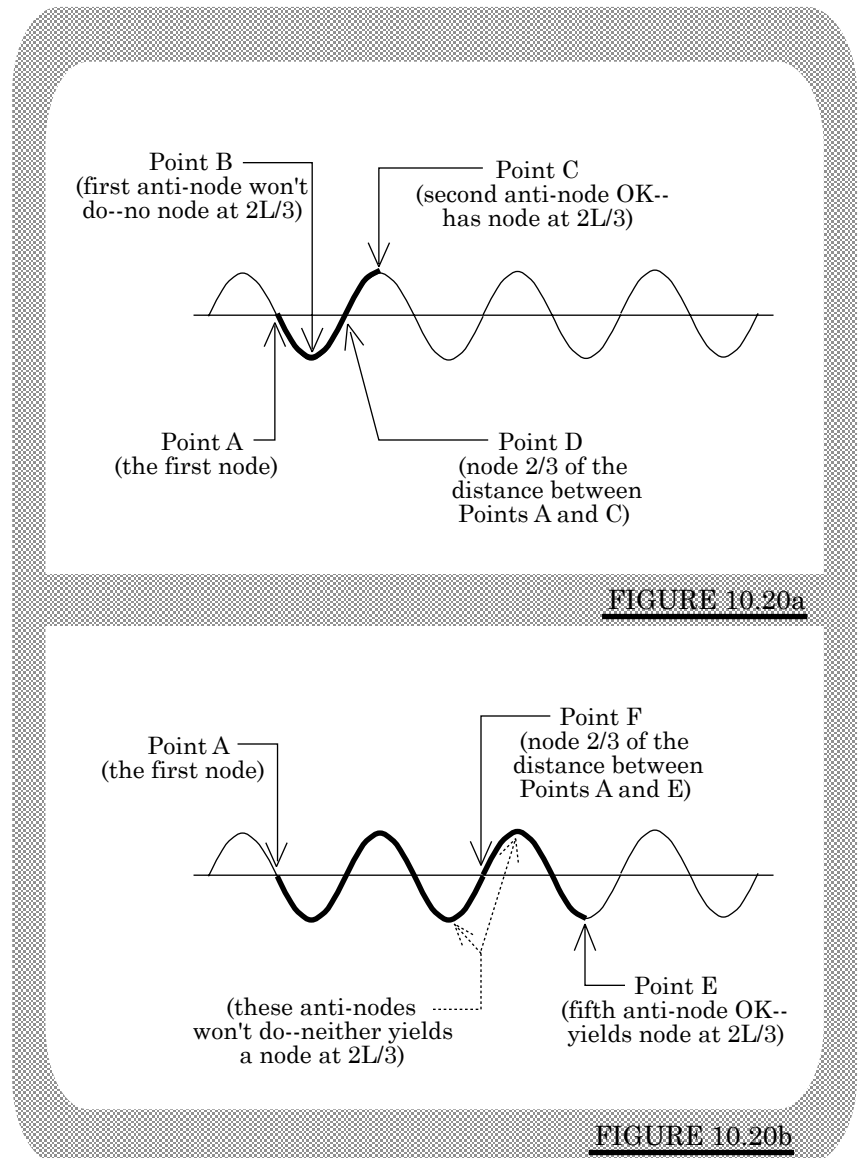

4.) Although we will use a *simple* situation to deduce the relevant points, the following observations should be helpful when dealing with *complex* standing wave problems. Consider: A system has a node at its left-end, an *anti-node* at its right-end, and an additional node-constraint $2/3$ of the way from the left-end. Calling this $2/3$ ratio the *fractional distance* between the mid-range node and the left-end constraint, what is the lowest frequency that will stand on this system?

a.) By observation, the waveform that fits the constraints is shown to the right in Figure 10.20c.

b.) The question? How can we be sure that the waveform satisfies the constraints of a system? That is, if we have a waveform that we think fits the bill, how can we check it?

c.) The approach:

i.) Count the number of *QUARTER WAVELENGTHS* in the waveform. In our example, there are 3 *quarter wavelengths*.

ii.) Note the *fractional distance* between one of the end-constraints (we have used the left-end *NODE* in our example) and the mid-range constraint (mid-range constraints are always nodes). In our example, this is $2/3$.

iii.) Determine the product of the *fractional distance* and the *number of quarter wavelengths in the waveform*. In our case, this equals $(2/3)(3) = 2$.

Note: If we had started at the other end (i.e., at the end constrained to act as an anti-node), the product of the *fractional distance* and the *number of quarter wavelengths* would have been $(1/3)(3) = 1$.

v.) Conclusion (not a proof, but it happens to be always true)

1.) If the product of the *fractional distance* and the *number of quarter wavelengths* equals a *WHOLE NUMBER*, then the waveform you are examining satisfies the mid-range constraint in question.

2.) If the product does *not* equal a whole number, the waveform does *NOT* satisfy the mid-range constraint.

vi.) For a waveform to stand (resonate) on a particular system, *ALL* of the mid-range constraints must satisfy the *fractional-distance/quarter-wavelength* test.

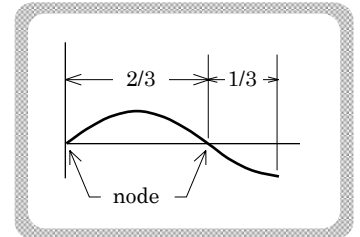

FIGURE 10.20c

F.) Resonance of Sound in Columns of Air:

1.) Sound is a longitudinal wave. It is made up of successive high, then low, then high pressure zones moving out through a medium.

a.) Figure 10.21a is the sketch of a sound wave as it would appear if your eyes were sensitive to pressure waves.

b.) Figure 10.21b graphs *pressure* as a function of *position in space* at a particular point in time.

c.) A pressure *difference* motivates air particles to move from higher to lower pressure.

d.) When standing waves are set up in air, the motion of the air medium is what dictates whether a particular point is a node or an anti-node.

e.) On either side of a pressure *maximum*, the pressure difference is very small, there is very little air motion, and with little motion

the medium (the air) acts like a node. On either side of a pressure *zero*, the pressure difference is very large, there is great air motion, and with much motion the medium acts like anti-nodes. In short, the graph used to analyze sound standing waves is really a *pressure difference* graph (see Figure 10.21b).

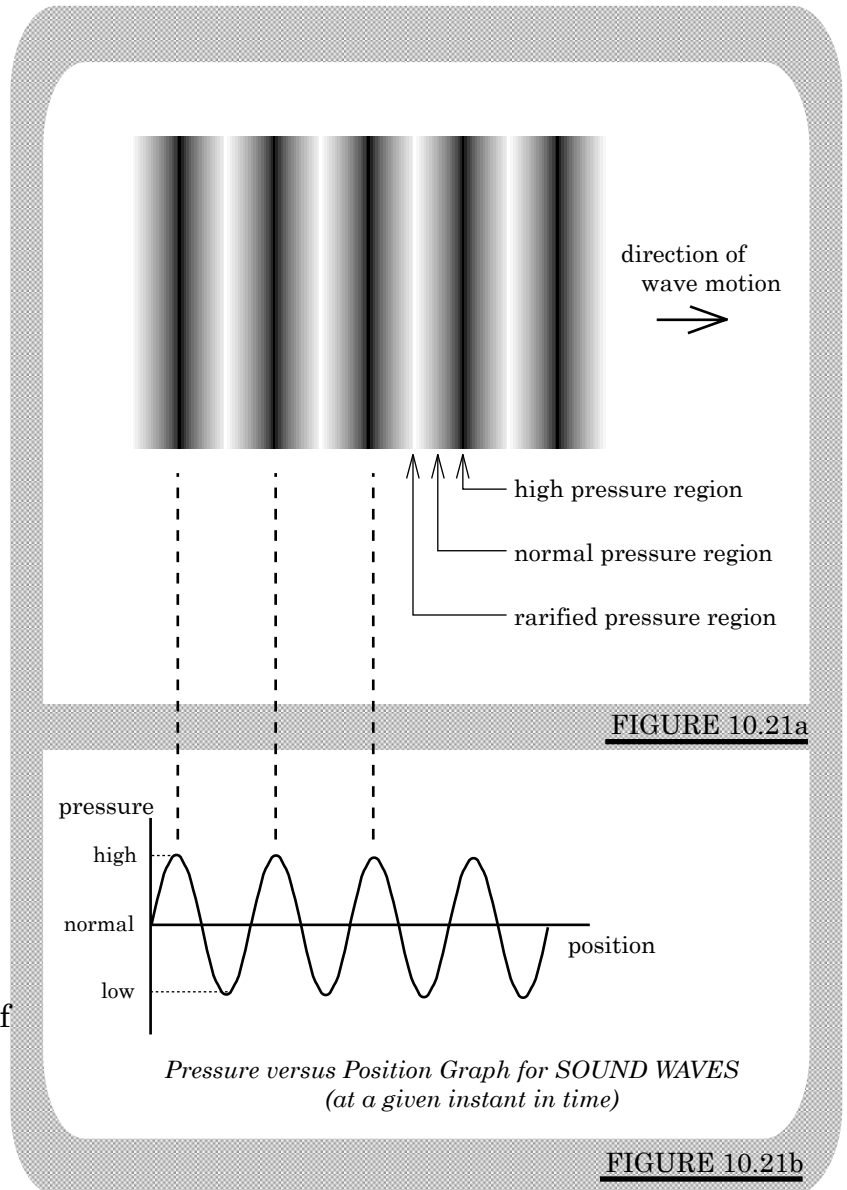

2.) When sound moving down a wave-guide bounces off a wall, it acts like a wave on a string bouncing off a fixed end. For sound-generated standing waves, a *node* will exist wherever the sound bounces off a *solid surface* (this is like saying that there is *no net air motion* at the wall). An *open surface* like the end of an open pipe (see Figure 10.22a, for example) acts like an *anti-node*. With this in mind, consider the following situation.

3.) A tube of known length L is open at one end and closed at the other (see Figure 10.22a). A series of sound waves is projected into the tube. What are the *three lowest frequencies* that will *resonate* in the air column?

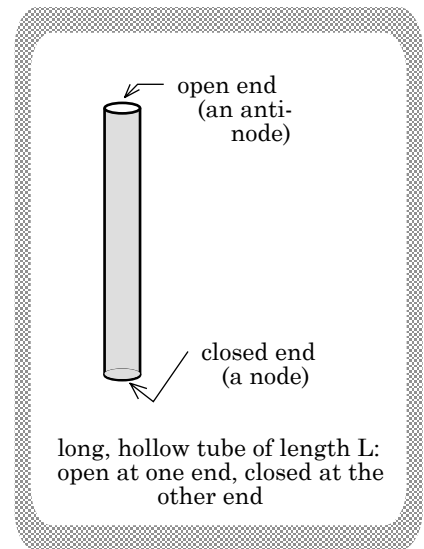

FIGURE 10.22a

a.) The constraints are: an *anti-node* at the top and a *node* at the bottom. There are no additional constraints in-between the ends (i.e., no baffles anywhere).

b.) Consider the sine wave drawn in Figure 10.22b (this *sine wave* is presented in both a vertical and horizontal setting: there is no difference--use the one that seems the least confusing). There are no *additional constraints* between the endpoints, so we will start at an *anti-node* (*Point A*) and proceed until we hit the first *node* (*Point B*). Making this distance equal to the tube's length L , we do the process.

c.) The math dictates:

$$\begin{aligned} (1/4) \lambda_1 &= L \\ \Rightarrow \lambda_1 &= 4L. \\ \text{As } v &= \lambda_1 v_1. \\ v_1 &= v/\lambda_1 \\ &= v/(4L). \end{aligned}$$

d.) $L = 1.5 \text{ m}$, the speed of sound in air is approximately 330 m/s, and remembering that THE UNIT FOR FREQUENCY is technically *1/seconds*:

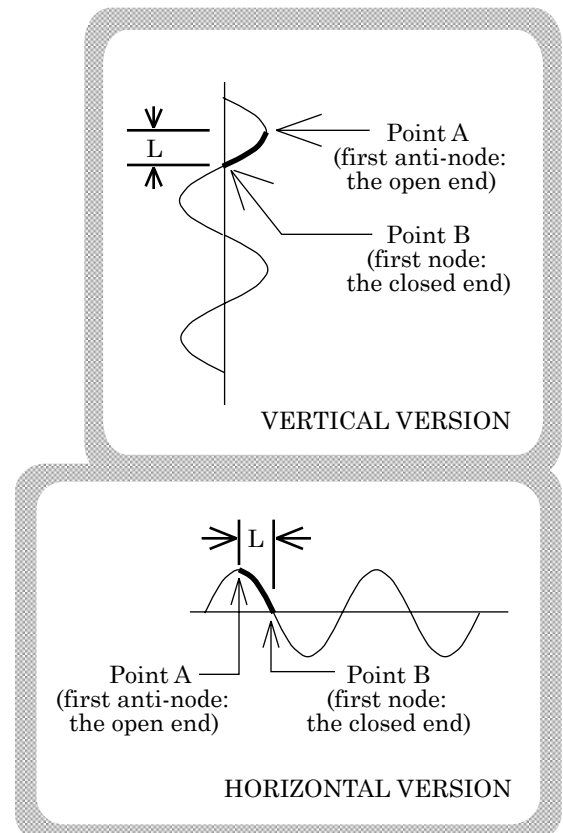

FIGURE 10.22b

$$\begin{aligned}
 v_1 &= v/\lambda_1 \\
 &= (330 \text{ m/s})/[(4)(1.5 \text{ m})] \\
 &= 55 \text{ Hz.}
 \end{aligned}$$

e.) The *second longest wavelength* is found in Figure 10.23 (we will use a vertical *sine wave* only).

The math yields:

$$\begin{aligned}
 (3/4) \lambda_2 &= L \\
 \Rightarrow \lambda_2 &= (4/3)L.
 \end{aligned}$$

$$\text{As } v = \lambda_2 v_2,$$

$$\begin{aligned}
 v_2 &= v/\lambda_2 \\
 &= (3v)/(4L). \\
 &= 3(330 \text{ m/s})/[(4)(1.5 \text{ m})] \\
 &= 165 \text{ Hz.}
 \end{aligned}$$

f.) The *third longest wavelength* is found in Figure 10.24. The math yields:

$$\begin{aligned}
 (5/4) \lambda_2 &= L \\
 \Rightarrow \lambda_2 &= (4/5)L.
 \end{aligned}$$

$$\text{As } v = \lambda_2 v_2,$$

$$\begin{aligned}
 v_2 &= v/\lambda_2 \\
 &= (5v)/(4L) \\
 &= 5(330 \text{ m/s})/[(4)(1.5 \text{ m})] \\
 &= 275 \text{ Hz.}
 \end{aligned}$$

4.) Now consider the same pipe open at *both* ends. What is the *third lowest frequency* at which this system will resonate?

a.) The constraints: anti-nodes at both ends.

b.) The waveform that conforms to our constraints and specifications (i.e., the *third lowest frequency*) is shown in Figure 10.25 to the right.

c.) From the sketch, we write:

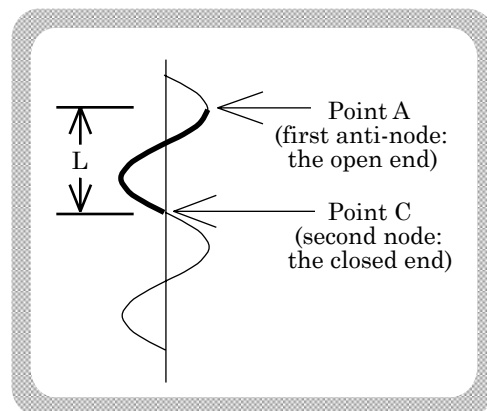

FIGURE 10.23

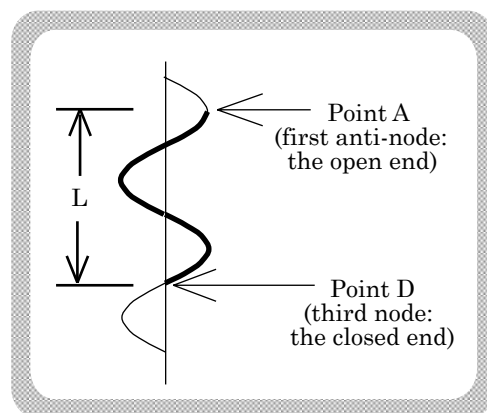

FIGURE 10.24

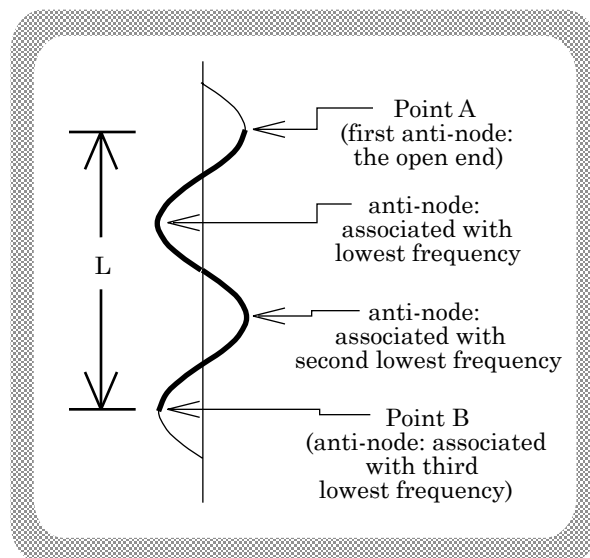

FIGURE 10.25

$$(3/2) \lambda_3 = L$$

$$\Rightarrow \lambda_3 = (2/3) L.$$

$$\text{As } v = \lambda_3 \nu_3,$$

$$\nu_3 = v/\lambda_3$$

$$= (3v)/(2L)$$

$$= 3(330 \text{ m/s})/[(2)(1.5 \text{ m})]$$

$$= 330 \text{ Hz.}$$

5.) Parting shot: Look at the constraints; draw your sketch; find l in terms of L ; then use $\nu = v/\lambda$ to determine the resonance frequency.

G.) Odds and Ends—Beats and the Doppler Effect:

1.) There are two other areas of wave phenomena that need to be briefly examined. The first is *beats*, the second is *the Doppler Effect*.

2.) BEATS:

a.) Figure 10.26 on the next page shows two equal-amplitude sound waves of slightly different frequency mingling with one another. The same figure also shows the superposition of those two waves.

b.) Because one waveform has a slightly higher frequency, it cycles a little bit faster than the other. That means that if both start out in phase (i.e., if both have their peaks and troughs initially aligned), the two will sooner or later go out of phase.

c.) When *in phase*, the superposition of the waves is constructive and the amplitude of the net wave is large (this corresponds to loud sound). When *out of phase*, the superposition of waves is destructive and there is no net wave (this corresponds to no sound).

d.) The frequency of this sound variation (sometimes called a *warble*) is called the *beat frequency* of the superimposing waves.

e.) Numerically, the *beat frequency* equals the *difference* between the two superimposing frequencies.

i.)

Example: A 220 Hz wave coexists with a 218 Hz wave. The beat frequency heard as a consequence of this superposition will be 2 cycles per second. If the frequencies had been 220 Hz and 222 Hz, the beat frequency would again have been 2 Hz.

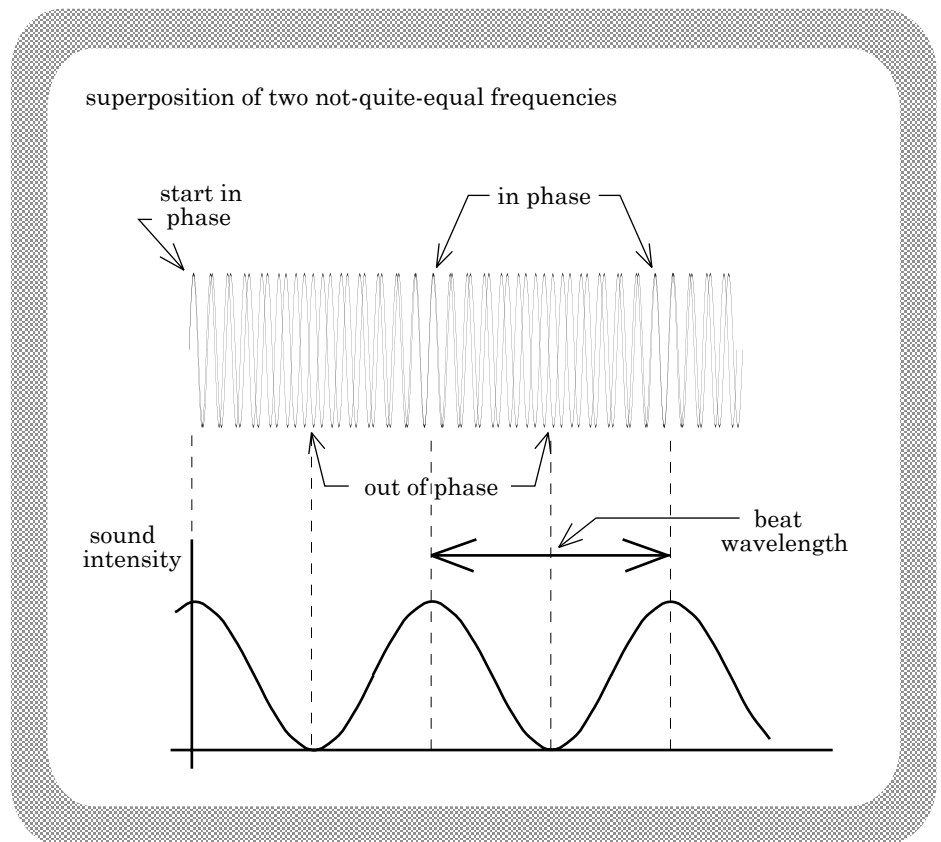

FIGURE 10.26

f.) Guitarists use beats in tuning their instruments. They do so by plucking two strings that, if tuned, will have the same frequency. If beats are heard, the strings are out of tune.

3.) The DOPPLER EFFECT:

a.) Have you ever had a train pass you while its whistle was being blown? The sound has a relatively high frequency as the train approaches, then abruptly drops in frequency after having gone by. This is the consequence of what is called *the Doppler Effect*.

b.) Consider a single sound source putting out sound of wavelength λ_1 . At regular intervals, a sound crest (i.e., a high pressure ridge) is emitted from the sound source and moves out at approximately 330 m/s (i.e., the speed of sound

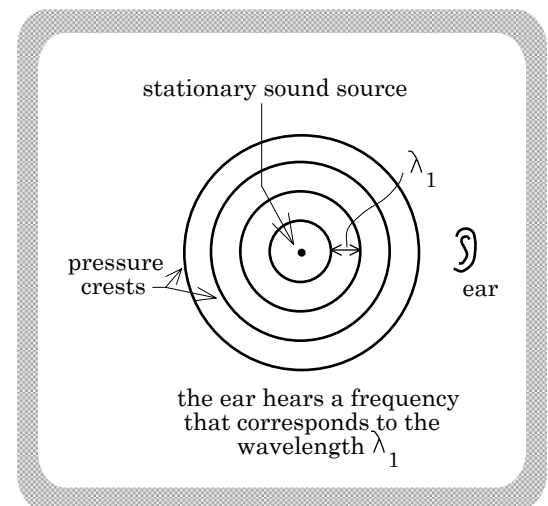

FIGURE 10.27

in air). Figure 10.27 on the next page shows a progression of such crests. Note that the listener in the sketch hears sound whose wavelength is λ_1 and whose frequency is $\nu_1 = v_{\text{sound}} / \lambda_1$.

c.) What happens when the sound source is moving toward the listener (or vice versa)? Figure 10.28 below shows the situation. Assume that at $t = 0$, the sound source puts out its first crest. After a time interval equal to the *period* T of the wave (remember, the period is the time required for one cycle to pass by . . . it is also equal to $1/\nu_{\text{source}}$), a second crest is emitted. After another period's worth of time, another crest is emitted, etc.

The distance between successive crests should be λ_1 , but that is not what the listener perceives. Why? Because the sound source is moving toward the listener. As such, the distance between crests is smaller than λ_1 .

d.) In fact, that wavelength will be the source's wavelength λ_1 minus the distance the source moved in time T (i.e., $v_{\text{source}} T$). Mathematically, this is:

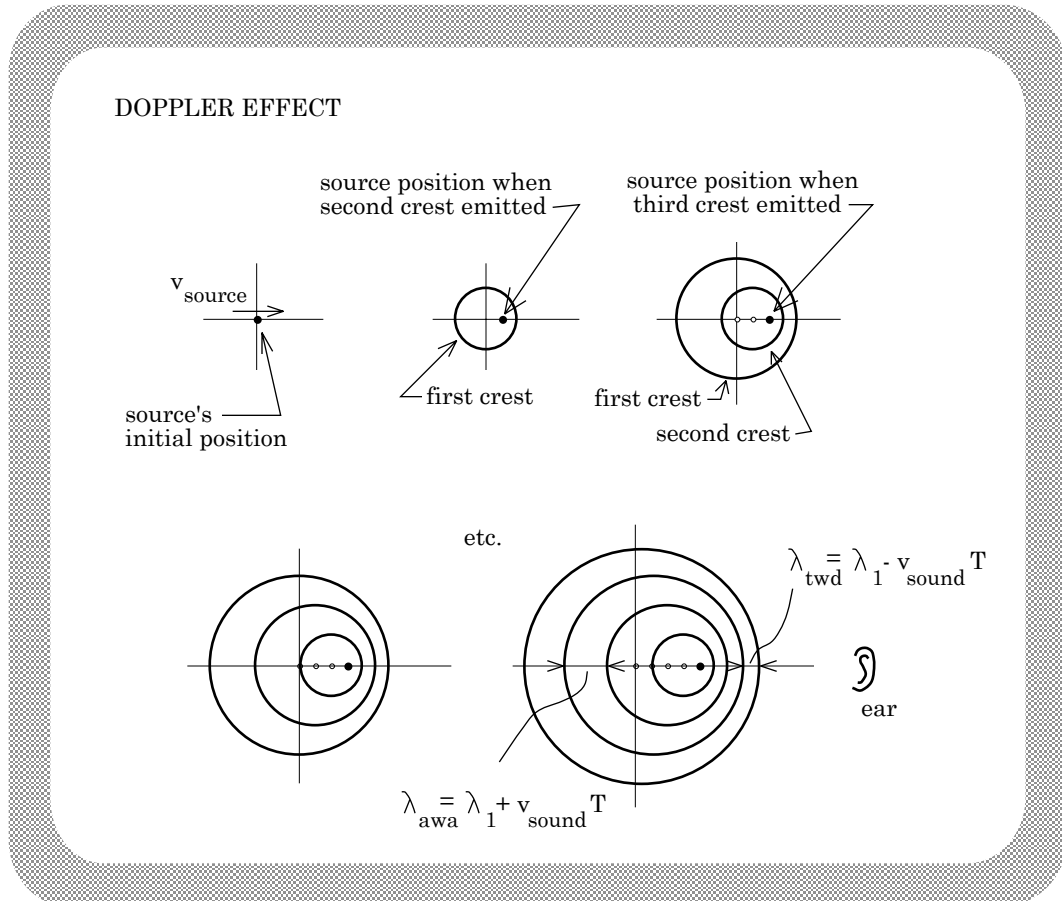

FIGURE 10.28

$$\lambda_{\text{new}} = \lambda_1 - v_{\text{source}} T \quad (\text{Equ. A}).$$

e.) As $T = 1/v_{\text{source}}$, $\lambda_{\text{new}} = v_{\text{sound}}/v_{\text{new}}$, and $\lambda_1 = v_{\text{sound}}/v_1$, we can substitute everything into *Equation A* and come up with the expression:

$$\frac{\lambda_{\text{new}}}{v_{\text{sound}}/v_{\text{new}}} = \frac{\lambda_1}{v_{\text{sound}}/v_{\text{source}}} - \frac{v_{\text{source}} T}{v_{\text{source}}/v_{\text{source}}}.$$

Rearranging yields:

$$v_{\text{new}} = v_{\text{sound}} v_{\text{source}} / [v_{\text{sound}} - v_{\text{source}}] \quad (\text{Equ. B}).$$

Note 1: If the source had been moving *away* from the listener, the expression would have had a *positive* sign in place of the *negative* sign.

Note 2: Looking at the Doppler Shift sketches in Figure 10.28, what would have happened if the velocity of the sound source had been *greater* than the velocity of sound itself?

The situation is pictured in Figure 10.29. In that case, a series of high pressure ridges would superimpose in such a way as to create a single, super-high intensity pressure ridge. This shock wave is what causes *sonic booms* when jets exceed Mach 1 (i.e., the speed of sound).

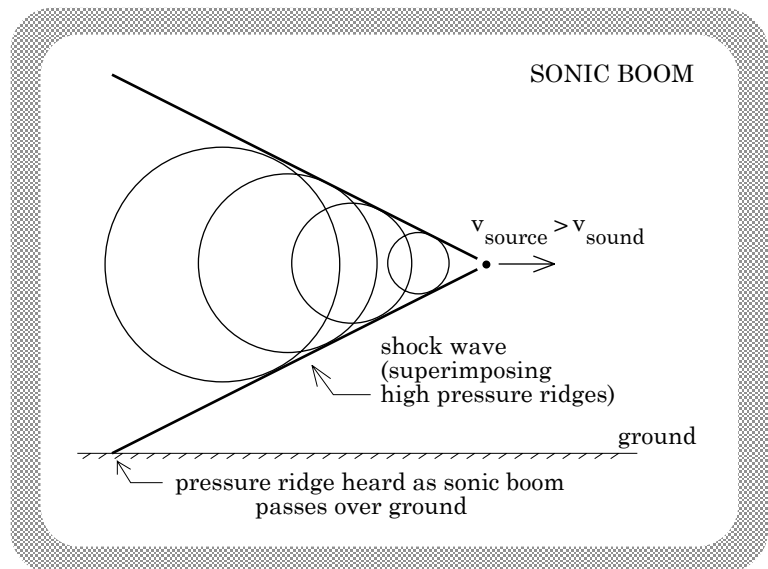

FIGURE 10.29

f.) Going back to the train whistle: When the train approaches, a listener will perceive crests coming in at a shorter

wavelength than the actual wavelength of the whistle (again, see Figure 10.28). Shorter wavelengths correspond to higher frequencies, which means the sound heard by the listener will be of a *higher* frequency than the whistle's actual frequency. By the same token, after the train passes the listener will hear a longer wavelength (i.e., lower frequency) sound.

As such, the train whistle seems to drop from high to low frequency as the train transits from *approaching* to *retreating*.

g.) The Doppler Effect is particularly useful in astronomy. White light is the superposition of all of the frequencies of electromagnetic radiation to which our eyes are sensitive. A prism (or, for that matter, a diffraction grating) can spread these superimposed frequencies out. That is why white light passed through a prism yields the colors of the rainbow.

Stars give off white light, but gases in the star's atmosphere absorb out certain frequencies. That means that when star light is passed through a prism or diffraction grating, frequency gaps called spectral lines are observed.

One particular gas, hydrogen, is found in the atmosphere of all stars. Its absorption spectra (i.e., the series of spectral lines that are absorbed out when white light passes through hydrogen) is well known. What is interesting is that when we look for the pattern of hydrogen spectral lines in light from stars, we find the lines, but we find them shifted toward the red end of the spectrum. That is, their calculated frequencies are *lower* than they should be.

This is a Doppler shift caused by the motion of the star relative to Earth. The shift is associated with light waves instead of sound waves, but the principles are the same. From the observed shift, we can deduce two things. First, as all star light seems to be red-shifted, all stars must be moving away from us (a shift toward lower frequency is observed when a wave source recedes from an observer). Second, by measuring how large the red shift is, we can determine the speed of the star relative to the earth.

i.) Example: A particular spectral line in the hydrogen spectrum should have a frequency of 6×10^{14} Hz. When observed from a star, the line seems to have a frequency of 5×10^{14} Hz. How fast is the star receding from the earth?

Solution: Using our frequency expression (Equ. B) and substituting the speed of light in for the speed of sound, we can write:

$$v_{\text{new}} = v_{\text{light}} \frac{v_{\text{source}}}{[v_{\text{light}} - v_{\text{source}}]}$$

$$(6 \times 10^{14} \text{ Hz}) = (3 \times 10^8 \text{ m/s})(5 \times 10^{14} \text{ Hz})/[3 \times 10^8 \text{ m/s} - v_{\text{source}}].$$

Solving for the velocity of the source, we get $v_{\text{source}} = .5 \times 10^8 \text{ m/s}$.

QUESTIONS

10.1) What, exactly, is a wave?

10.2) In Star Wars, a giant galactic battle cruiser is attacked in space by a host of little single engine fighters. Cannons from the battle cruiser blaze as the tiny fighters swarm around it. You see a fighter hit, blowing up spectacularly with a ferocious outpouring of light and fire and a cacophonous kaboom. What's wrong with this picture?

10.3) How many wavelengths are there between a crest and its adjacent trough? Between every third crest? Between every two successive troughs?

10.4) You are on a pier watching ocean waves pass by. Six crests pass you by in 25 seconds. If there are approximately 20 meters between crests:

- a.) Will the wavelength of the train be a whole number?
- b.) If the number of waves passing by every 25 seconds was halved, what would the period do?
- c.) How is the wave velocity related to the time it takes for a full wave to pass by?
- d.) What is the wave frequency?
- e.) How is the wave velocity related to the frequency of the wave train?
- f.) A student is given the following scenario: *A closed, empty plastic water bottle is thrown off the end of the pier (bad form!) and into the waves. If the pier is 100 meters long, how long will it take the bottle to hit the beach?* The student complains that this is a trick question. Explain why he or she might think so.

10.5) What is the difference between a *wave* and a *standing wave*?

10.6) What *kind* of waves are your ears sensitive to? What makes these waves this type?

10.7) What has to be true for resonance to occur?

10.8) The waveform for the lowest frequency that will "stand" in a tube of length L is shown to the right. Calling the speed of sound in air v_{air} :

- a.) What is the wavelength of the waveform?
- b.) What is the frequency of the waveform?

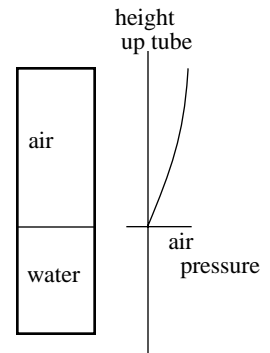

c.) A frequency that is twice the frequency calculated in *part b* is projected down at the tube. Will the tube howl the way tubes do when resonance is present? Explain.

10.9) Two waves moving in the same medium meet and pass by one another. What single word describes how the waves will interact while they are coexisting in the medium?

10.10) When a guitarist is using beats to tune a guitar, does the player want the beat frequency to increase or decrease as he/she gets the instrument closer to being tuned.

10.11) It's night time. You are lying on a train track, minding your own business, just looking at the stars with your pals. All of a sudden, you hear a train whistle. Half of your friends yell, "Oh, s__t, a train is coming," and jump up off the track. The other half chide, "Ah, you big sissy, the train is going the other way," and stay put. You happen to have perfect pitch, and because you are an aficionado of train whistles, you know what the train whistle's frequency sounds like when you are on the train traveling with it. If your "I'm not going to move" friends are correct, how will the frequency you actually hear compare to the whistle frequency you hear when traveling with the train?

10.12) You have a motor that runs at a constant speed. You attach to the motor's shaft a gear and plunger assembly that displaces water in a very large pond (in fact, the pond is so large that you can ignore any returning waves that have bounced off the pond's edges, so big is the pond). As night falls, the water temperature drops. As a consequence, will wavelength the traveling waves produced by the constant frequency plunger increase, decrease, or stay the same. Explain.

10.13) A hollow, U shaped tube is partially filled with water. When sound is projected at the system, the system resonates when the sound source's frequency is ν_j . If you pour water into the system, thereby raising the water level, will the new resonance frequency be greater, smaller, or the same as the old resonance frequency? Explain.

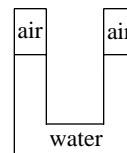

PROBLEMS

10.14) On the assumption that one's hearing has not been ruined by loud music or contact with intense noise, good ears can hear sounds between 20 Hz and 20,000 Hz.

- a.) What is the wavelength associated with a 20 Hz sound wave? How does this compare with everyday size?
- b.) What is the wavelength associated with a 20,000 Hz sound wave? How does this compare with everyday size?

10.15) Three different waves are generated so as to coexist in the same medium as they move to the right. Figure I shows the outline of the three waves as they would appear if they were to exist alone.

- a.) Make an approximate sketch of the wave that would actually exist in the medium--i.e., the superimposed wave (do it lightly in pencil directly on Figure I).

- b.) All the waves are moving with the same speed but their *amplitudes* and *angular frequencies* are different. As can be seen, each wave is a sine wave which means each can be characterized using $x = A \sin \omega t$ (the *amplitudes* and *angular frequencies* are different but the general form of each wave's expression is the same). Using the information available on the graph to determine the appropriate

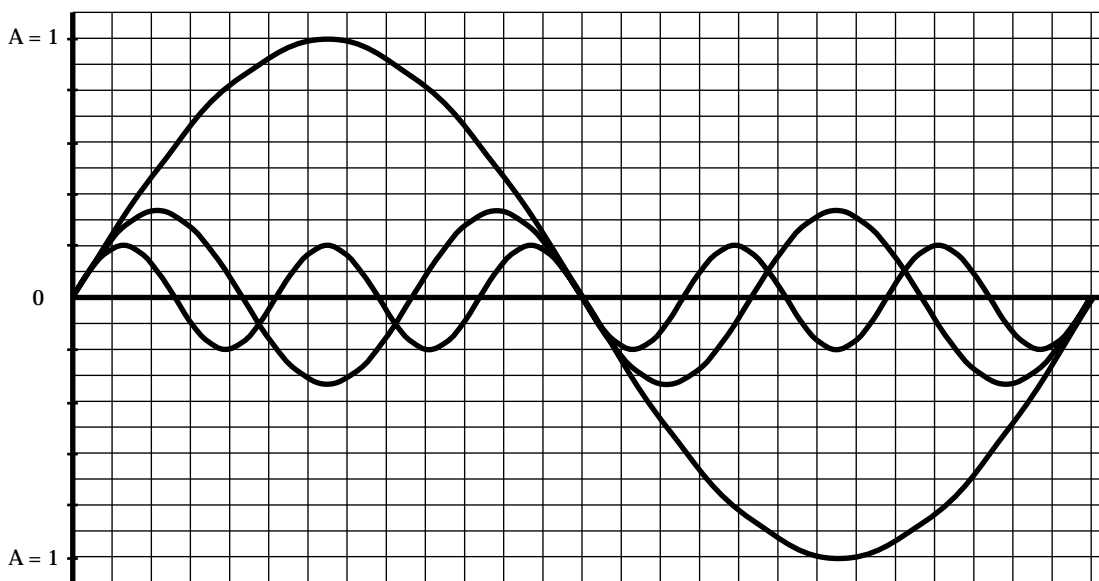

FIGURE I

parameters, write out the *algebraic expression* that characterizes the superposition of these three waves. That is: take the largest wave's *amplitude* and *angular frequency* and assume each is numerically equal to 1; determine the *amplitude* and *angular frequency* of the other two waves RELATIVE TO THE LARGEST (use the sketch and your head to get the required information); write the $x = A \sin \omega t$ expression for all three waves; then add them.

c.) In looking at the expression determined in *Part b*, you should see a pattern. Following the pattern, write out the first six terms of the series that seems to be emerging. (Note: If you look at the series from *Part b* in *fraction form*--that is, for instance, using $1/4$ instead of $.25$ --the pattern should become obvious.)

d.) By looking at the superimposed wave you drew in *Part a*, you should get a feel for the general wave form to which the series is converging. Draw a sketch of that wave form.

10.16) For the *traveling wave* characterized below:

$$y(x,t) = 12 \sin (25x - .67t).$$

- a.) Sketch y as a function of x from $t = 0$ to $t = 1$ second.
- b.) Is this *traveling wave* moving to the right or the left?
- c.) What can you conclude about the *negative sign* between the x term and the t term in the function? That is, in what direction would the wave have traveled if that sign had been *positive*?
- d.) Determine the wave's *frequency*;
- e.) Determine the wave's *period*;
- f.) Determine the wave's *wavelength*;
- g.) Determine the wave's *velocity*;
- h.) Determine the wave's *amplitude*.

10.17) A *traveling wave* moving left has a *frequency* of 225 Hz, an *amplitude* of .7 meters, and a *wave velocity* of 140 m/s. Characterize the wave mathematically.

10.18) A damaged meterstick (length $L = .8$ meters) having a mass of $m = .4$ kg is pinned through one end and made to swing back and forth executing *small-angle* oscillations. Newton's Second Law for this situation (i.e., after a *small angle approximation* is made) yields the equation:

$$(2/3) \alpha + (g/L) \theta = 0.$$

- a.) Determine the *resonant frequency* of the swinging meter stick.

b.) If small, periodic, tangential forces (i.e., a sequence of pushes designed to make it swing) are applied to the bottom of the stick over time, will its amplitude of motion become large or stay small if the *period* of the applied pushes is:

- i.)** 1.31 seconds/cycle (approximately);
- ii.)** 1.47 seconds/cycle (approximately)?

10.19) A violin string vibrating at 800 Hz has five nodes along its length of .3 meters (this includes two nodes at the ends). What is the *velocity* of the wave on the string?

10.20) Determine the *third* lowest resonant frequency for each of the systems shown in Figure II. Assume you know L and the wave velocity v .

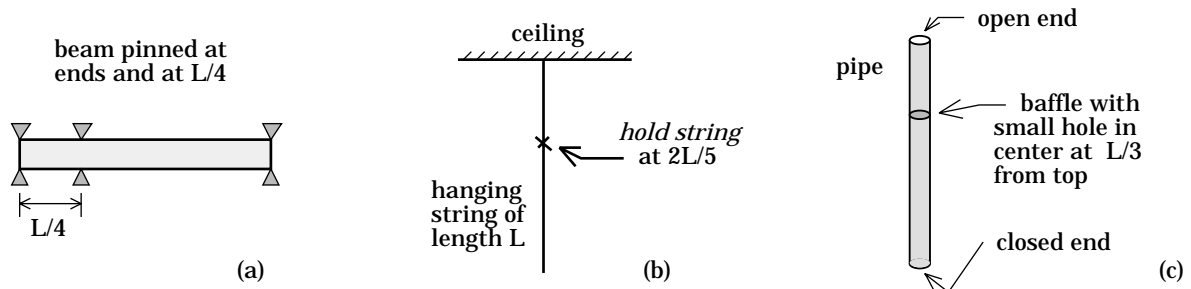

FIGURE II

